

11632**87-93 SUBARU SEDAN**

12/14/2012

GROSS LOAD CAPACITY WHEN USED AS A WEIGHT CARRYING HITCH: 1,500 LBS. TRAILER WEIGHT & 150 LBS. TONGUE WEIGHT.

*****DO NOT EXCEED VEHICLE MANUFACTURER'S RECOMMENDED TOWING CAPACITY.*****

WARNING: ALL NON-TRAILER LOADS APPLIED TO THIS PRODUCT MUST BE SUPPORTED BY 18050 STABILIZING STRAPS.

**** FAILURE TO PROPERLY SUPPORT NON-TRAILER LOADS WILL VOID PRODUCT WARRANTY****

HAVING INSTALLATION QUESTIONS? CALL TECHNICAL SUPPORT AT 1-877-287-8634

Parts List			
ITEM	QTY	PART NUMBER	DESCRIPTION
1	2	7/16-14 x 1.63 x 2.50 C-C	SQ. U-BOLT
2	4	3/8 - 16 x 1 1/4	HEX BOLT
3	4	3/8"	FENDER WASHER
4	2	CM-SP102	.25 x 1.75 x 2.00 SPACER
5	4	HFN3816	HEX FLANGE NUT
6	4	7/16-14	HEX FLANGE NUT

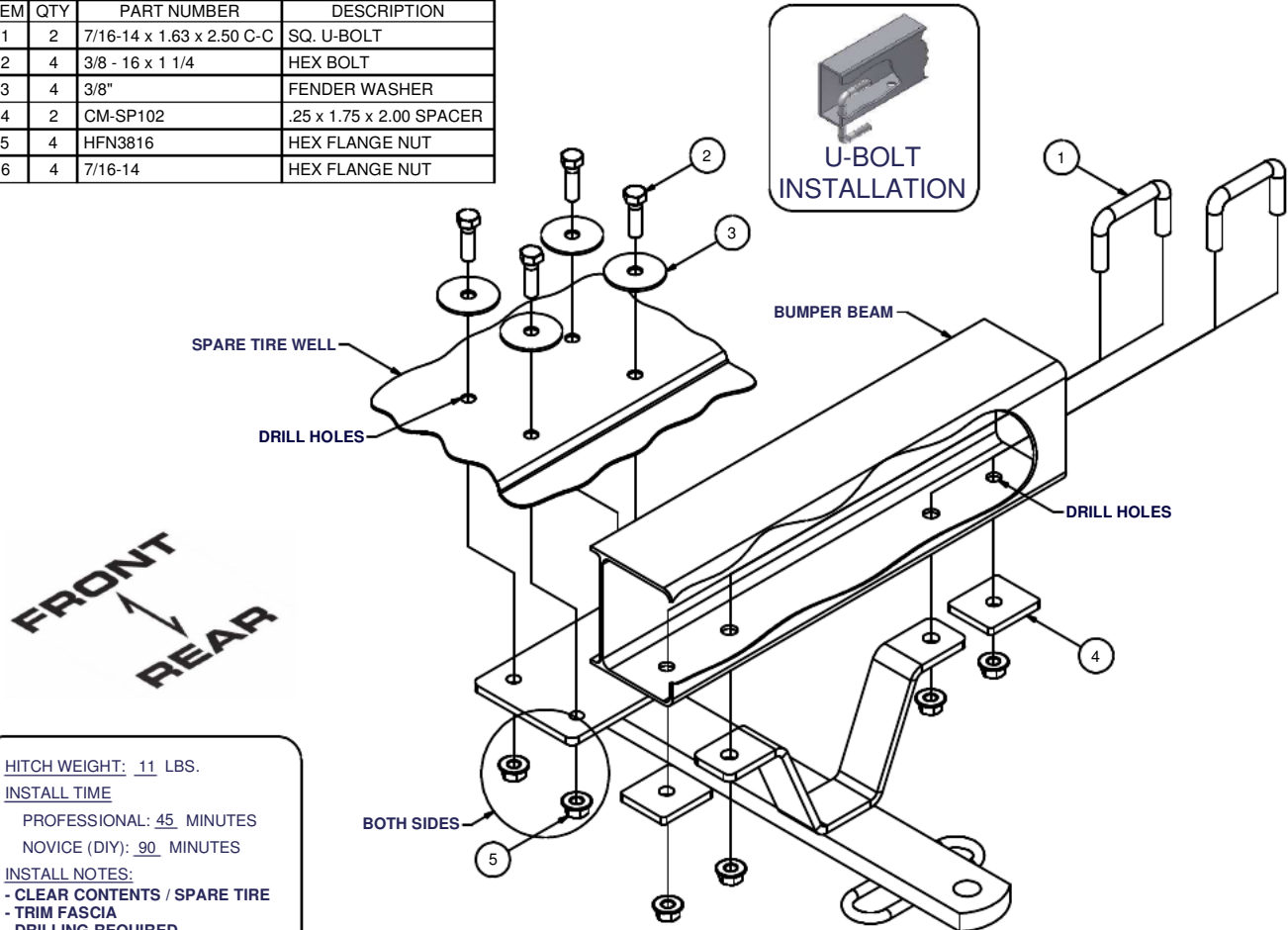

HITCH WEIGHT: 11 LBS.

INSTALL TIME

PROFESSIONAL: 45 MINUTES

NOVICE (DIY): 90 MINUTES

INSTALL NOTES:

- CLEAR CONTENTS / SPARE TIRE
- TRIM FASCIA
- DRILLING REQUIRED
- SILICONE SEAL HARDWARE

INSTALLATION STEPS

1. Remove contents from the spare tire well. Mark the vehicle's centerline and the underside of the rear bumper. Hold the hitch in place centered and square on the vehicle. Position the hitch for hitch ball clearance, and mark plastic fascia and retaining strip for trimming on certain models only. Hitch brackets must fit directly against the metal bumper beam and metal spare tire well.
2. Trim the plastic fascia and the retainer as necessary. Hold the hitch in place on the vehicle and use it as a template to mark for all holes. Drill spare tire well for 3/8" hardware and bumper beam for 7/16" hardware.
3. Position (2) rectangular u-bolts into bumper beam as shown in diagram. Mount the hitch to the vehicle using fasteners as shown. NOTE: Do not use impact wrench on U-bolts and place fender washers inside of spare tire well.
4. Torque all 3/8" fasteners to 45 lb-ft, and all 7/16" fasteners to 70 lb-ft.
5. Use silicone sealant to seal hardware installed through spare tire well.
6. Reinstall contents removed in Step 1.

PERIODICALLY CHECK THIS RECEIVER HITCH TO ENSURE THAT ALL FASTENERS ARE TIGHT AND THAT ALL STRUCTURAL COMPONENTS ARE SOUND.

Curt Manufacturing Inc., warrants this product to be free of defects in material and/or workmanship at the time of retail purchase by the original purchaser. If the product is found to be defective, Curt Manufacturing Inc., may repair or replace the product, at their option, when the product is returned, prepaid, with proof of purchase. Alteration to, misuse of, or improper installation of this product voids the warranty. Curt Manufacturing Inc.'s liability is limited to repair or replacement of products found to be defective, and specifically excludes liability for incidental or consequential loss or damage.